

Panasonic

CORDLESSPHONE

MODEL NO. **KX-T3806BA**

EASA-PHONE

Pulse-or-tone dialing capability

Operating Instructions

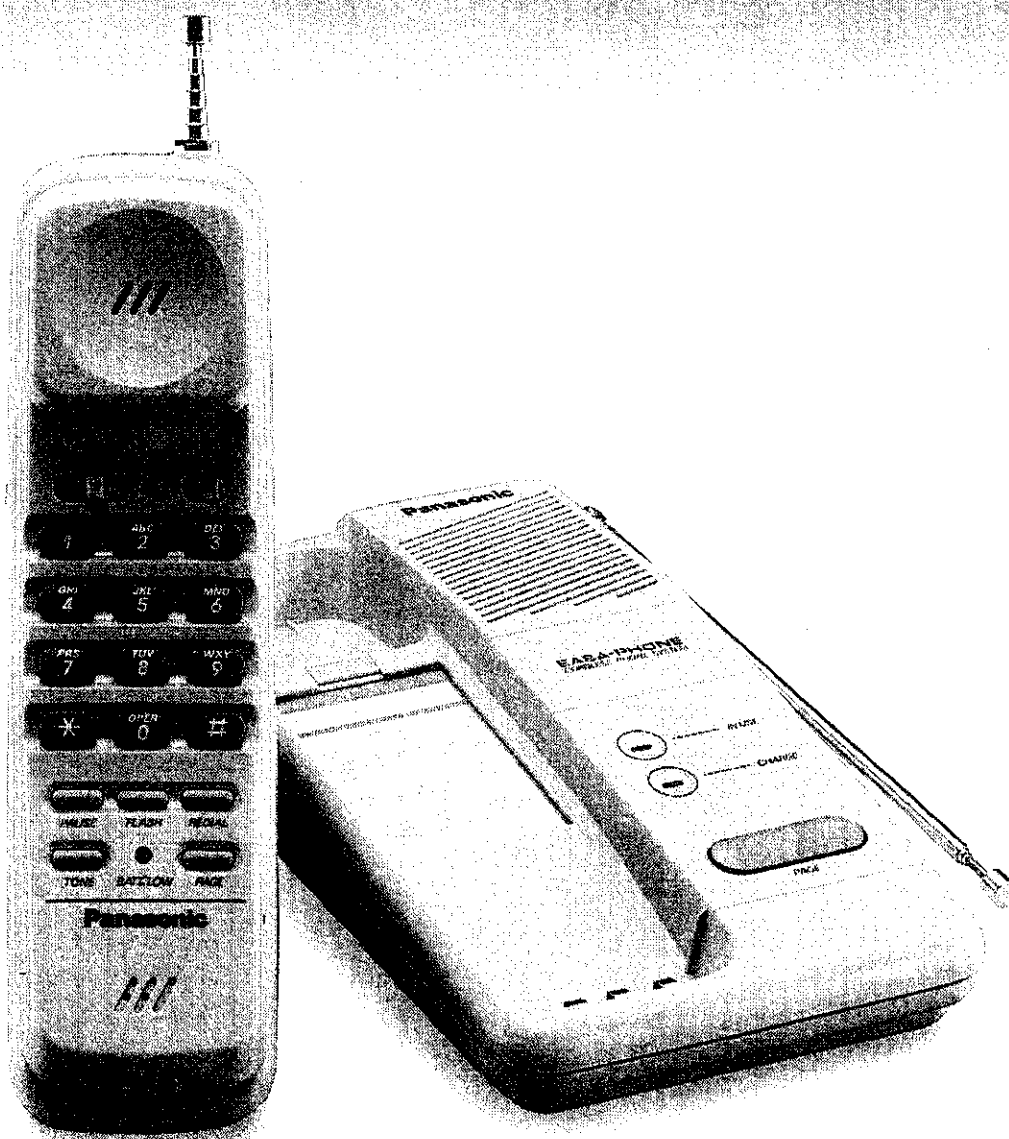

Charge the battery for about 10 hours before initial use.

Please read before use.

Precaution

Before using this unit, please read these operating instructions carefully. Take special care to follow the safety suggestions listed below.

Safety

1) Power Source:

The unit should be connected to a power supply only of the type described in the operating instructions or as marked on the unit.

2) Nonuse Periods:

When the unit is not used, turn the power off. When left unused for long periods of time, the base unit should be unplugged from the household AC outlet.

Installations

Environment

1) Water and Moisture:

Do not use this unit near water - for example, near a bath tub, washbowl, or the like. Damp basements should also be avoided.

2) Heat:

The unit should be situated away from heat sources such as radiators and the like. It also should not be placed in rooms where the temperature is less than 5°C or greater than 40°C.

Placement

1) Foreign Material:

Care should be taken so that objects do not fall into and liquids are not spilled into the unit. Do not subject this unit to excessive smoke, dust, mechanical vibration, or shock.

2) Magnetism:

The unit should be situated away from equipment or devices that generate a strong magnetic field.

3) Stacking:

Do not place heavy objects on top of this unit.

4) Surface:

Place the unit on a flat, level surface, or use the wall mounting adaptor for wall installation.

For best performance

1) Both the base unit and portable unit should be used with the antennas fully extended.

2) The unit should be situated away from the personal computer, television, radio or fax. They may interfere with each other.

3) If noise prevents the conversation from being understood at the portable unit, approach the base unit to lessen the noise.

4) The portable unit should be used at the "HIGH" volume setting when the reception tone is difficult to hear.

5) The portable unit should be fully recharged on the base unit when the BATT. LOW indicator flashes.

6) The small-sized antenna of the portable unit should not be touched during the use because of its high sensitivity.

7) The possible calling distance may be shortened when the unit is used in the following places.

Near obstacles such as hills, tunnels, undergrounds, near metal object such as wire fence, etc.

Contents

Location of Controls	3
Connection	7
Initial preparation	9
Making calls	11
Answering calls	13
Transferring an incoming call	15
2-way paging	16
Other features	
Temporary tone dialing	17
FLASH button	17
PAUSE button	18
Combination dialing	18
Charging the portable unit	19
Battery replacement	20
Wall mounting	21
Troubleshooting guide	22
Others	22

Location of controls

PORTABLE UNIT

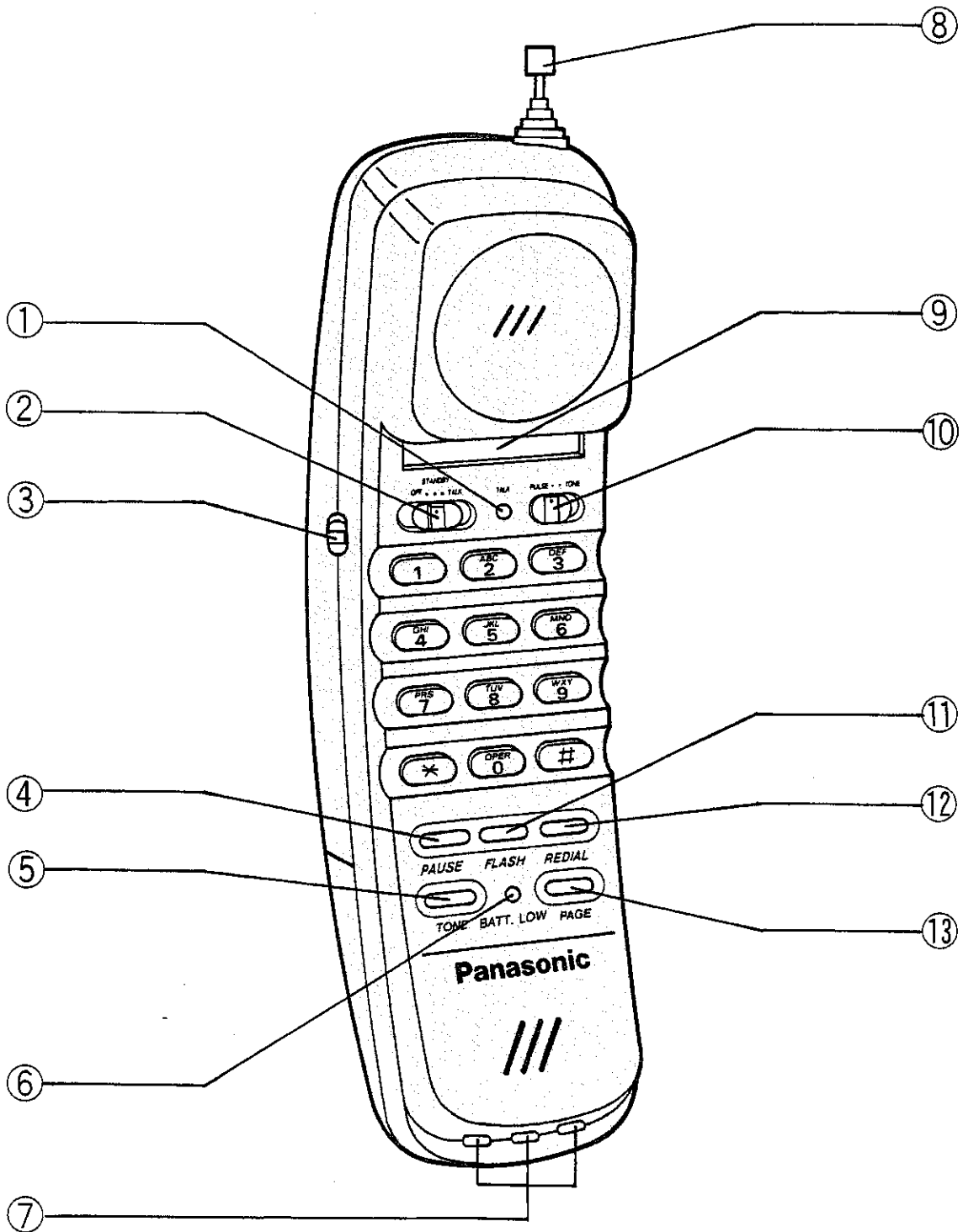

① TALK Indicator

② Function Selector : Used to turn the unit on and off.
Used to making call and answering call.
See page 10.

③ VOLUME Selector : Used to adjust the volume level of the portable unit.
See page 10.

④ PAUSE Button : Used to pause during a dialing operation.
See page 18.

⑤ TONE Button : Used to change the dialing mode from pulse to tone during a dialing operation.
See page 17.

⑥ BATT. LOW Indicator

⑦ Battery Charge Contacts

⑧ Antenna

⑨ Number Card : Used to write your telephone number.

⑩ DIALING MODE Selector : Used to select either Pulse or Tone dialing.
See page 10.

⑪ FLASH Button : Used to access some features of your host PBX and your telephone company.
See page 17.

⑫ REDIAL Button : Used to redial the last dialed telephone number.
See page 12.

⑬ PAGE Button : Used to page the base unit.
See page 16.

Location of controls

BASE UNIT

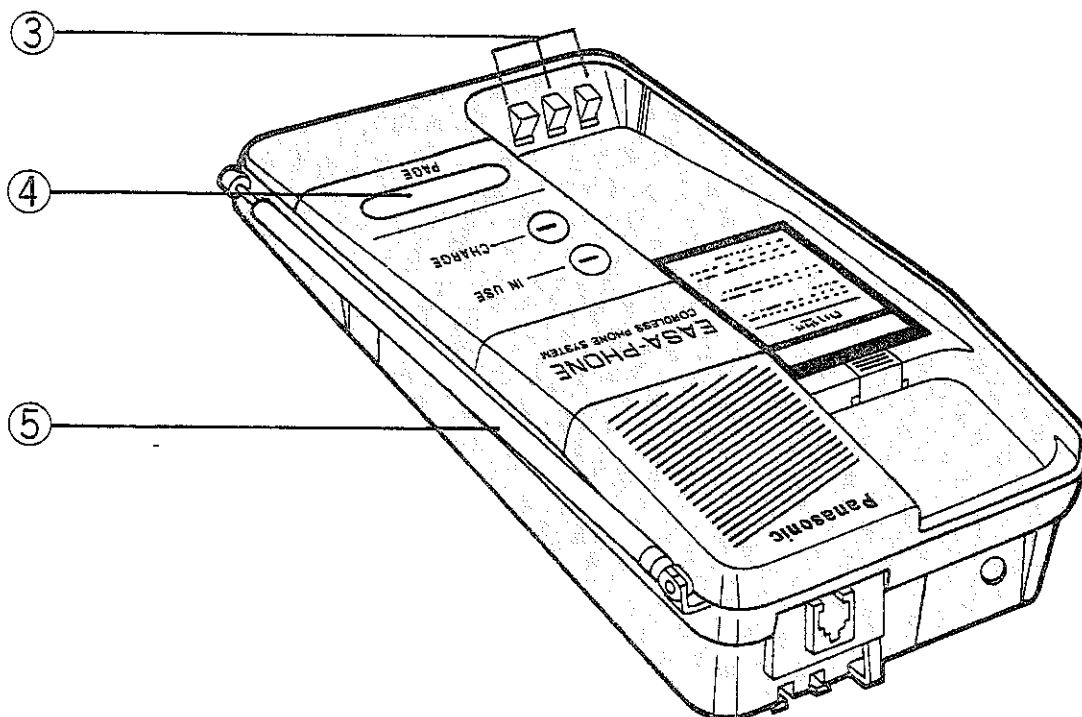
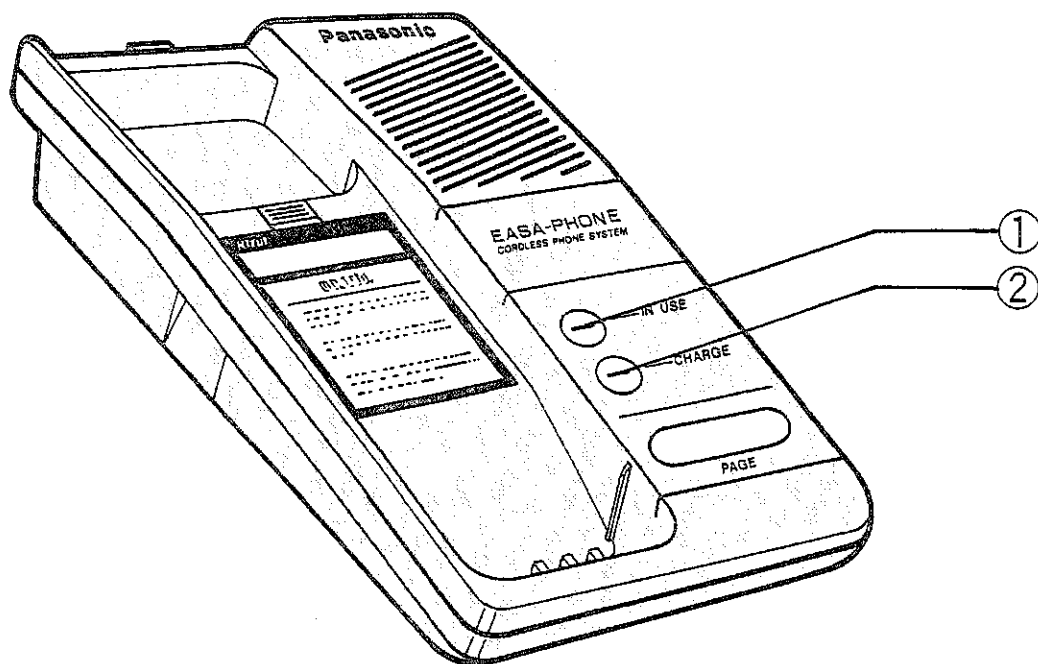

①IN USE Indicator

②CHARGE Indicator

③Battery Charge Contacts

④PAGE Button : Used to page the portable unit.
See page 15.

⑤Antenna

Connection

Connect the unit with the telephone line and the AC Adaptor.

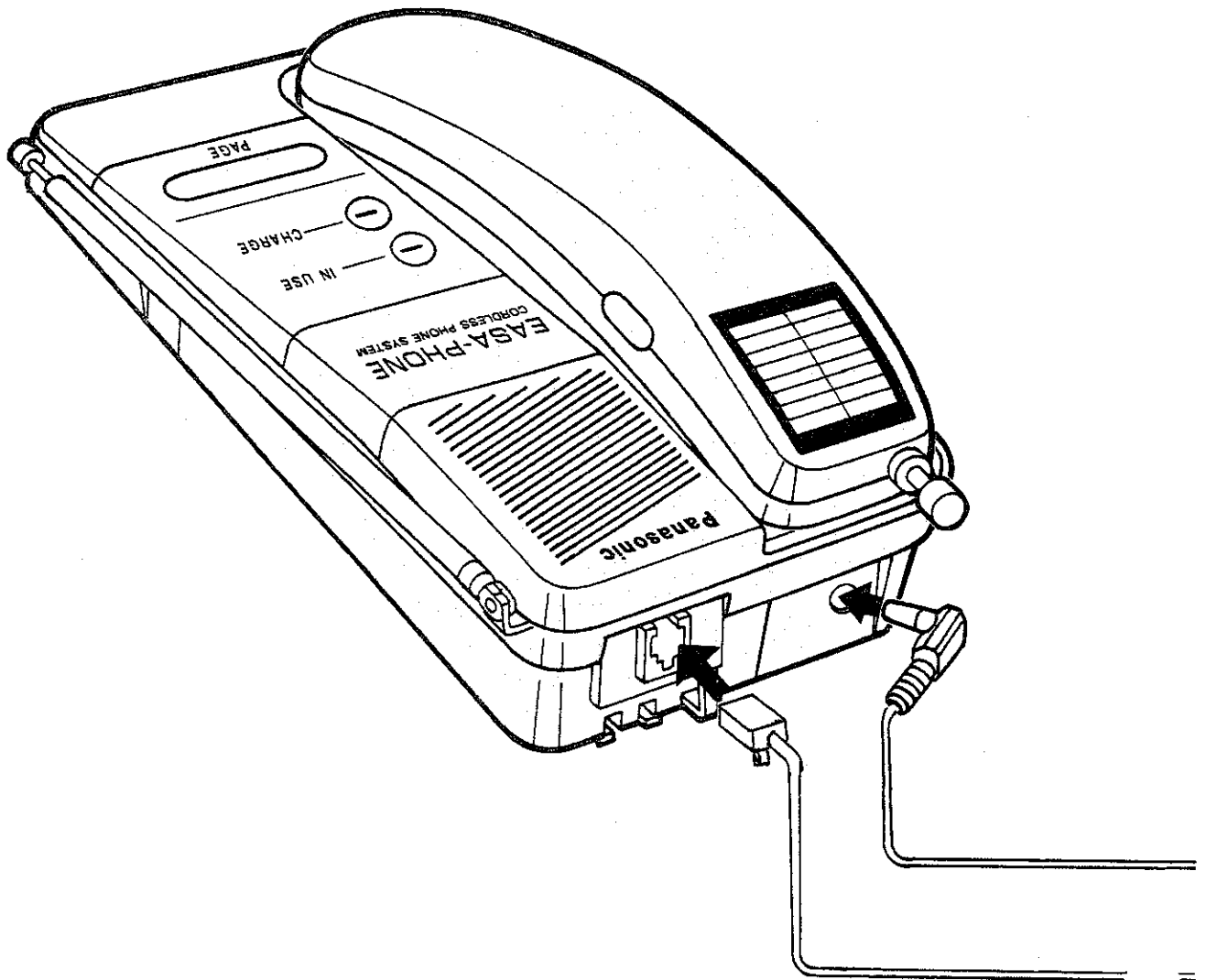

Fasten the cord to the cord holder

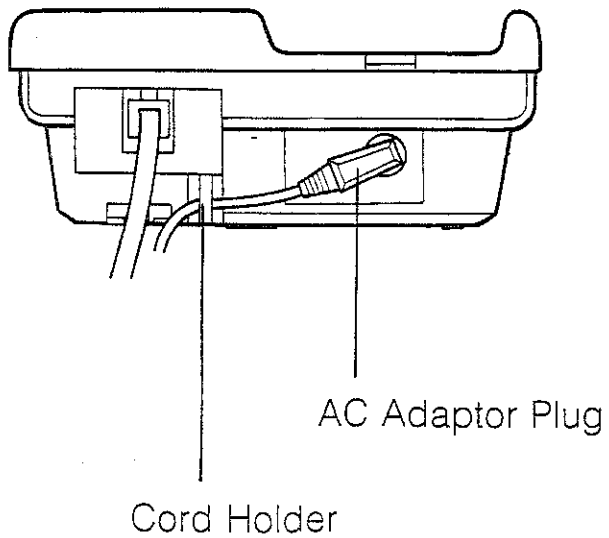

To connect another telephone on the same line, please use T-Adaptor.

To Telephone Line

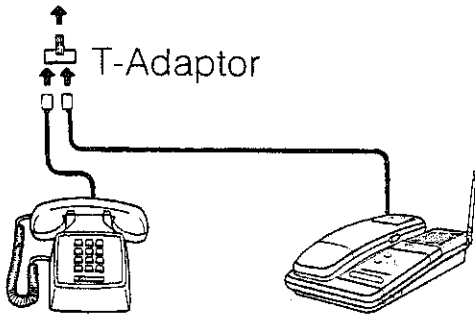

Another Telephone KX-T3806BA

1 Charge the battery about 10 hours by placing the portable unit on the cradle. See page 19.

2 Extend the antennas fully for the best performance.

- The possible calling distance may vary depending on length of the antennas extended.

Use only Panasonic AC Adaptor, KX-A10BA.

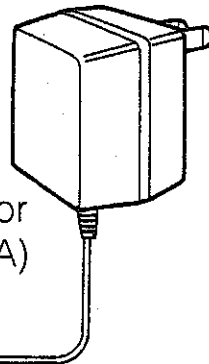

To power outlet (AC 240V, 50Hz)

AC Adaptor (KX-A10BA)

To telephone line

Telephone Line cord

Accessories

- AC Adaptor one

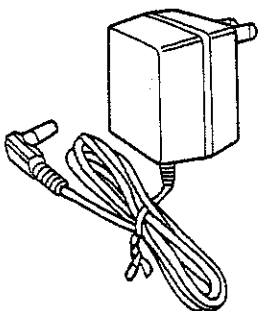

- Wall-mounting adaptor one

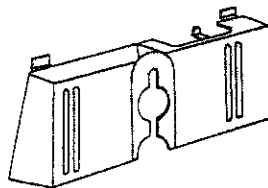

- Screws two
- Washers two

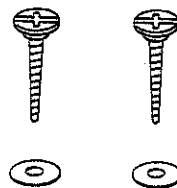

- Telephone Line cord one

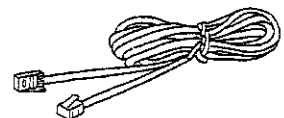

Initial preparation

Charge the portable unit for about 10 hours before initial use.

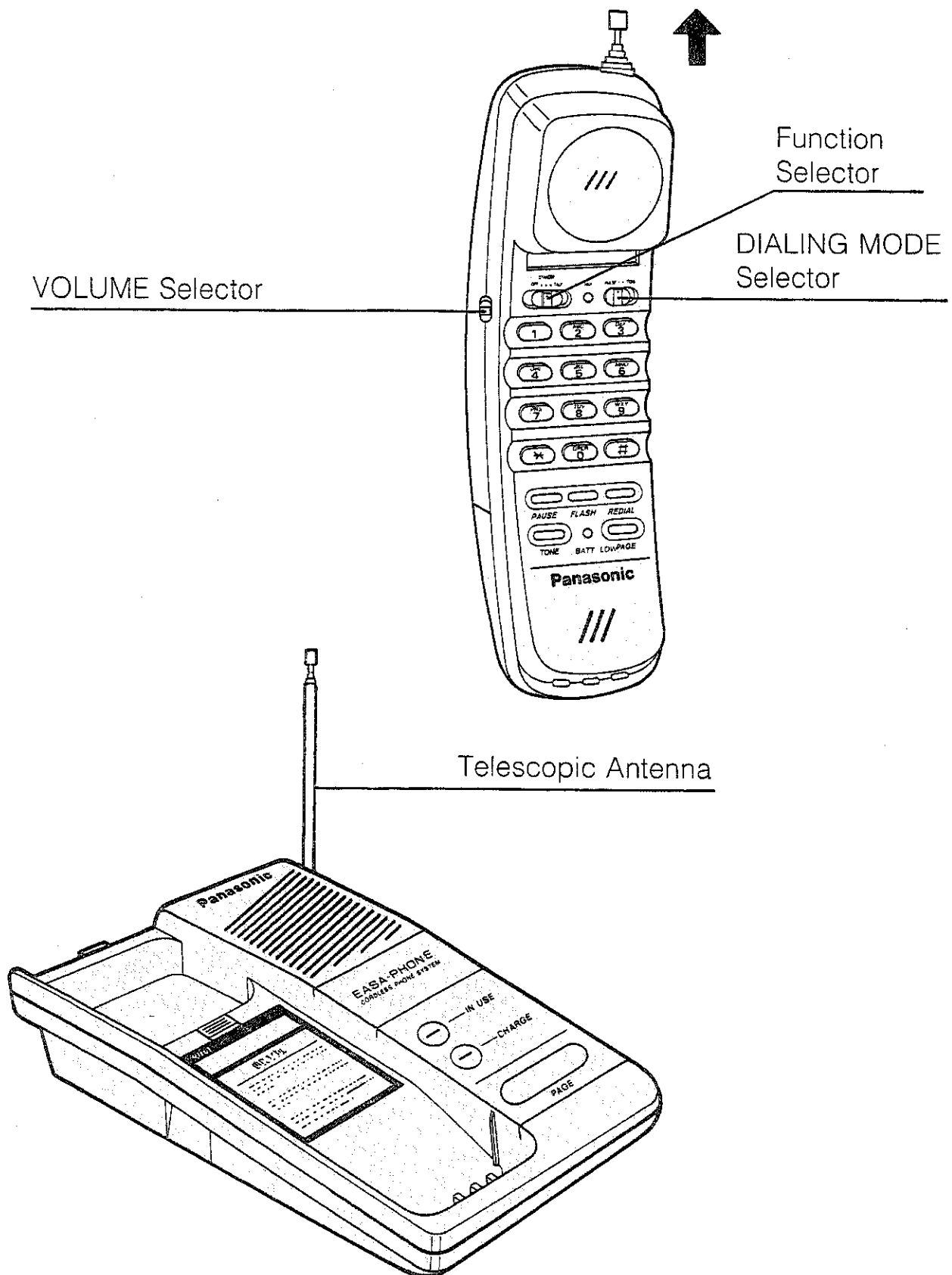

Note: Extend the Telescopic Antenna for best performance.

1

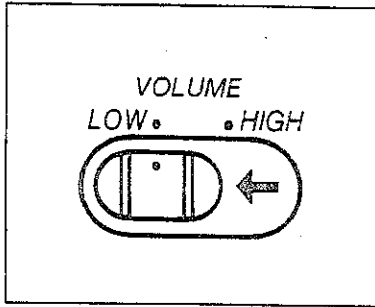

VOLUME Selector:

Set the VOLUME selector to the "LOW" position.

When the other party's voice is difficult to hear, set the selector to the "HIGH" position.

2

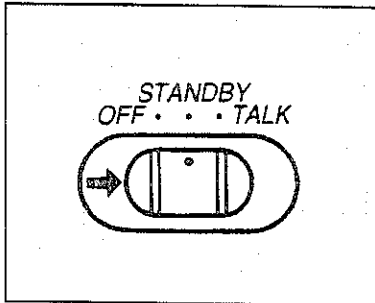

Function Selector:

Set the function selector to the "STANDBY" position.

- When you do not want the telephone to ring, set the function selector to the "OFF" position.
- If you do not use the unit for a long time, set the function selector to the "OFF" position.

3

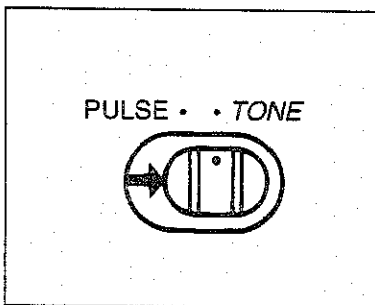

DIALING MODE Selector:

Set the DIALING MODE Selector on the portable unit to the "TONE" position if your telephone line has touch tone service. If it has rotary dial pulse service, set the selector to the "PULSE" position.

4

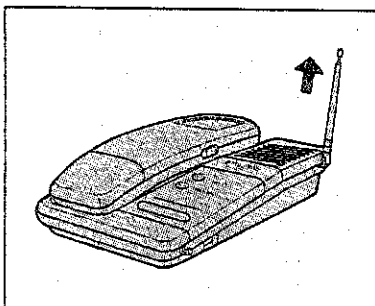

Telescopic Antenna:

Extend the Telescopic Antenna of the base unit fully and vertically for the best performance.

Making calls

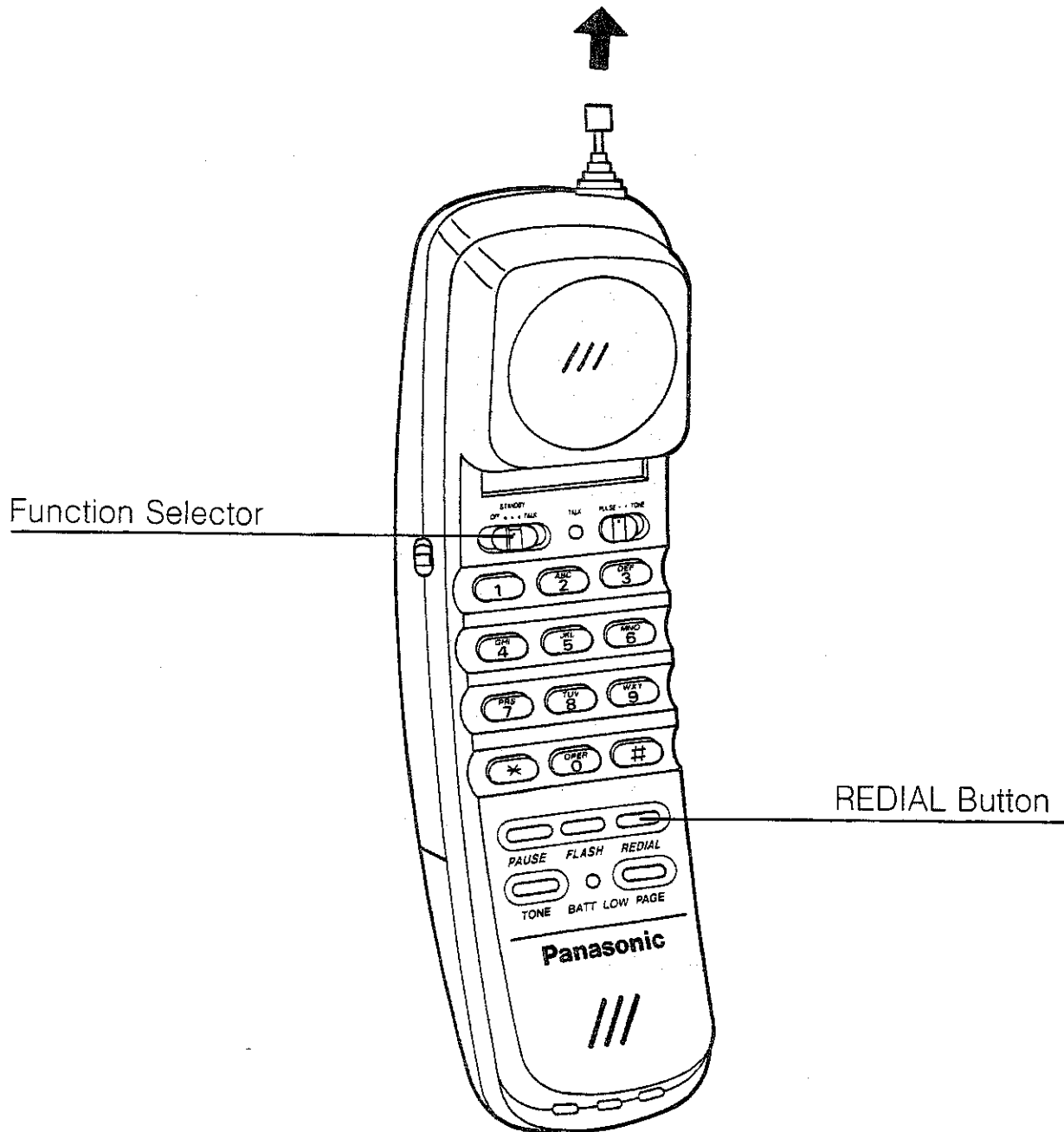

Note:

- Extend the Telescopic Antenna for the best performance.

1

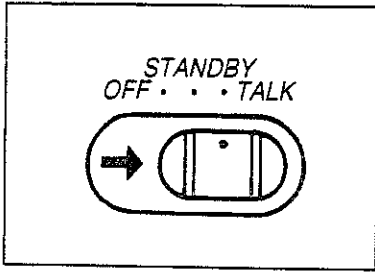

Set the function selector to the "TALK" position.

The TALK indicator light is on.

2

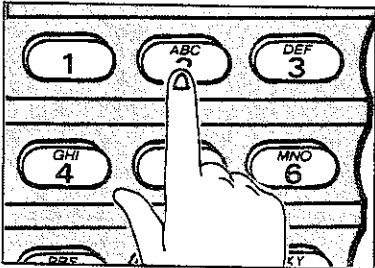

Dial the telephone number.

3

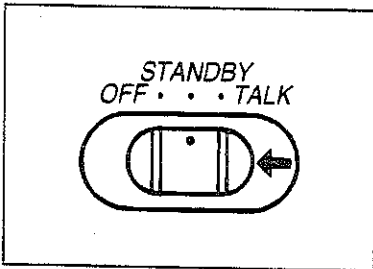

When your conversation is over, set the function selector to the "STANDBY" position.

The TALK indicator light goes out.

■ Using the REDIAL button,

The unit can redial the last dialed number.

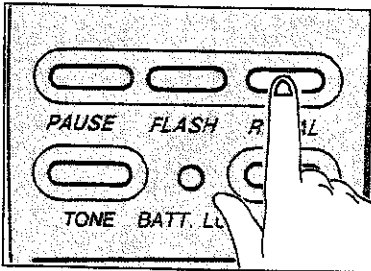

Pressing the REDIAL button enables you to redial once.

Answering calls

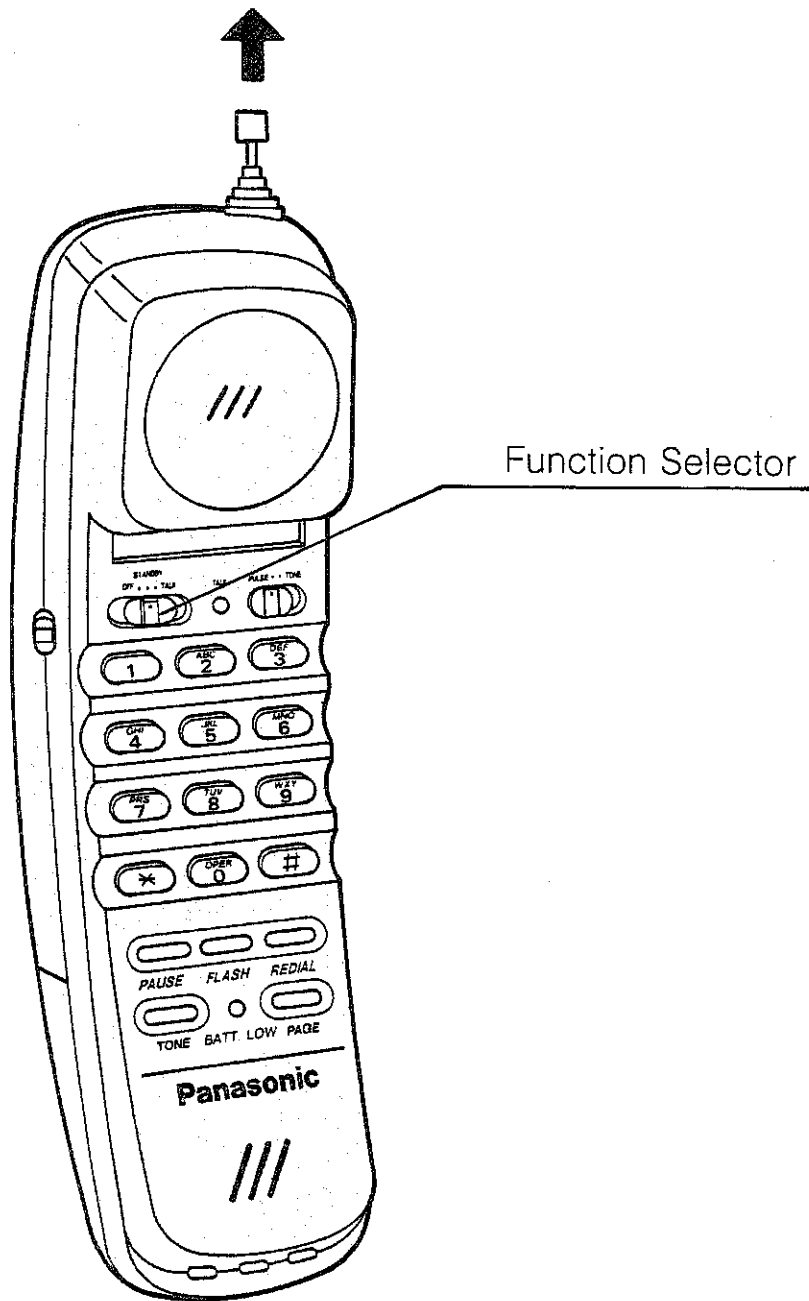

Note:

- Extend the Telescopic Antenna for best performance.

Be sure that the function selector is set to "STANDBY" position.

1

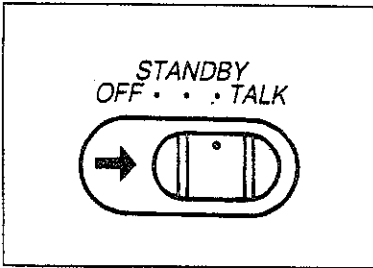

When the telephone rings, set the function selector to the "TALK" position and answer the call.
The TALK indicator light is on.

2

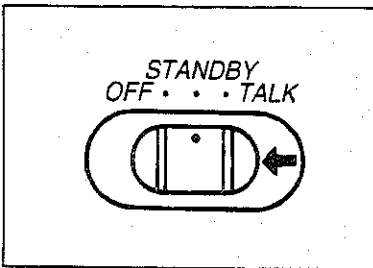

When your conversation is over, set the function selector to the "STANDBY" position.
The TALK indicator light goes out.
● When the function selector is set to "OFF", the unit will not ring.

Transferring an incoming call

The base unit user will be able to receive a call and transfer it to the portable unit.

This is done by connecting another telephone on the same line to the base unit with the T-Adaptor.

Transferring from the base unit to the portable unit

1 The base unit user:

Pick up the handset of another telephone connected on the same line to the base unit to answer the incoming call.

2

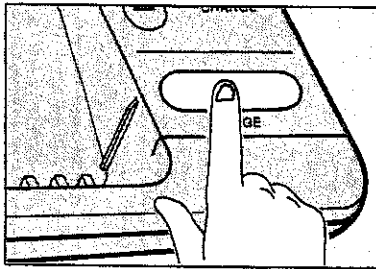

Press the PAGE button to page the portable unit user.

3

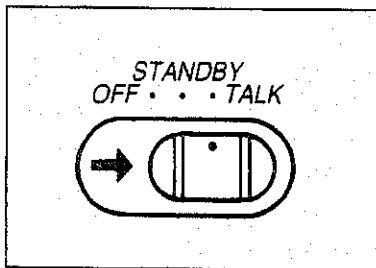

The portable unit user:

When the beep sounds, set the function selector to the "TALK" position and answer the incoming call.

- For a three way conversation, keep the handset off-hook.

4 The base unit user:
After confirming IN USE indicator light is on, the another telephone may hang up.

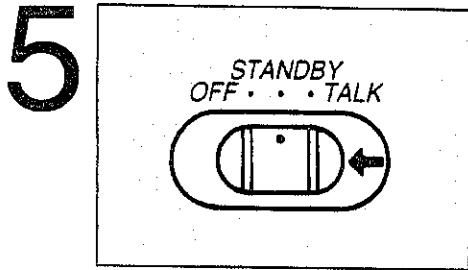

The portable unit user:
When your conversation is over, set the function selector to the "STANDBY" position.
The TALK indicator light goes out.

2-way Paging

To call Portable Unit from Base Unit

1 Press the PAGE button.

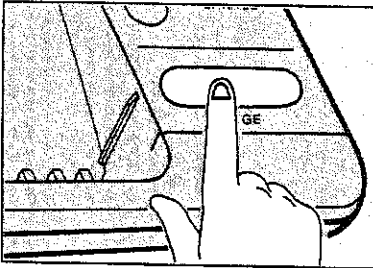

To call Base Unit from Portable Unit

Be sure the function selector is set to the "STANDBY" position.

1 Press the PAGE button.

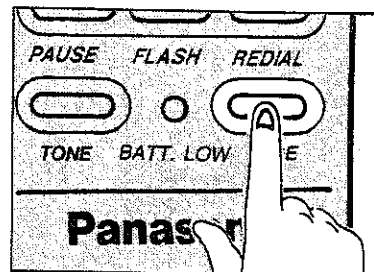

Other features

Temporary tone dialing

Use the TONE button when your line has rotary telephone service. Pressing it will allow you to change the dialing mode from pulse to tone during a dialing operation, and enter special tones and codes to operate answering machine, electronic banking services and other special services.

"TONE" can be programmed into memory stations with the telephone numbers.

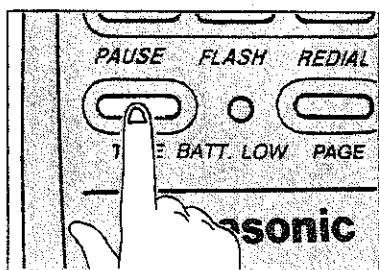

Press the TONE button.

When you set the function selector to the "STANDBY" position, the dialing mode will automatically return to pulse mode.

FLASH button

The FLASH button is used to access special telephone services such as call waiting and call forwarding.

For further details, please see a brochure issued by your telephone company.

- 1 While having a conversation, another party calls and tone is heard.
 - 2 Press the FLASH button.
 - The first conversation is placed on hold and the second call can be answered.
 - 3 When you finish your conversation with another party press the FLASH again.
 - The first caller can be spoken to again and the second call is placed on hold.
- You may access some features of your host PBX using the FLASH button.

PAUSE button

The PAUSE button is used in a dialing sequence to access an outside line.

■ Using the PAUSE button

When the unit is connected to your PBX's extension, enter the line access number and a pause to access an outside line.

Also when redialing, a pause may be required by your host PBX.

Example: If the line access number is "9", press "9" and the PAUSE button. Then dial the telephone number.

9 — PAUSE — Phone Number

Combination dialing

The following combinations of dialing methods can be used.

- Manual dialing
- Pulse and Tone dialing

Charging the portable unit

Charge the battery of the portable unit for about 10 hours before initial use, or if the BATT. LOW indicator on the portable unit flashes.

Place the portable unit on the cradle.
The CHARGE indicator light is on.

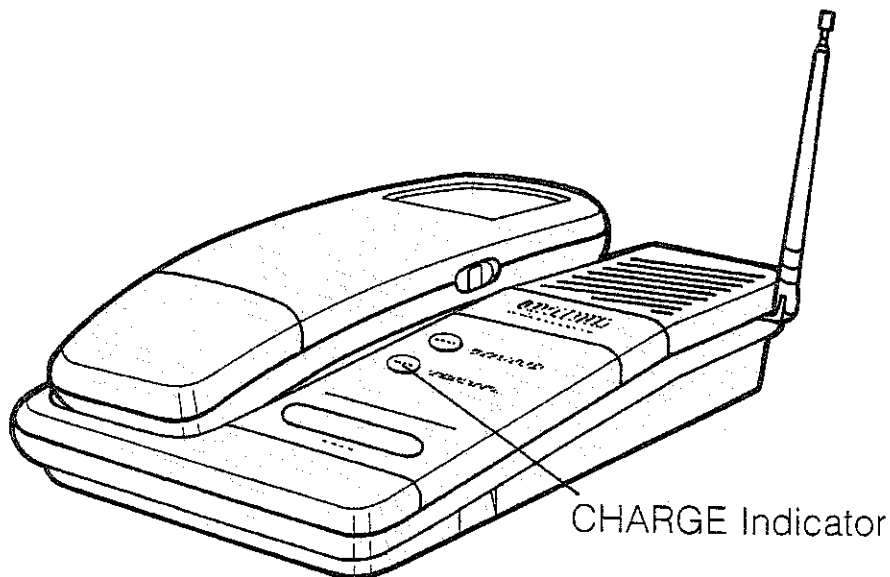

You can use the unit before 10 hours are up. But be sure to put the portable unit on the cradle so it can continue charging.

Note:

- Even when the BATT. LOW indicator flashes, the portable unit will still function for a short period of time.
- Recharging is required after a long interval, as the unit will consume some battery power gradually when not being on the cradle while in the "STANDBY" mode. If you will not use the unit for a long period of time, set the function selector to the "OFF" position.
- Clean the battery charge contacts with a soft cloth about once a month, otherwise the portable unit may not be charged properly.

Battery replacement

If the BATT. LOW indicator flashes after a few telephone calls even when the battery has been charged for 10 hours, replace it.

1

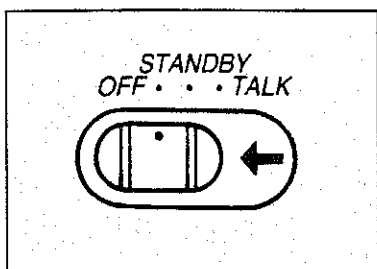

Be sure that the function selector is set to the "OFF" position.

2

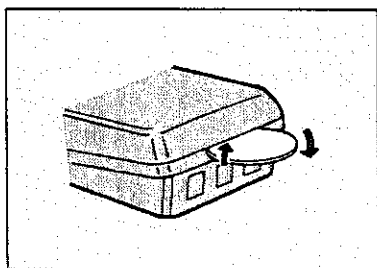

Remove the battery compartment cover using an object such as a coin.

3

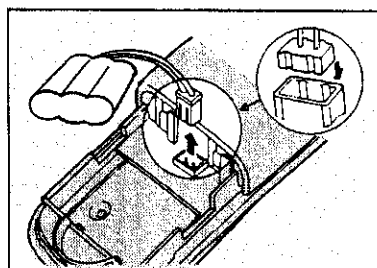

Replace the battery.

Note:

- Please use only Panasonic KX-A36A.
- Remember to charge the battery for 10 hours.

Wall mounting

This unit can be mounted on the wall utilizing the washers and screws provided.

1. Turn over the handset guide.

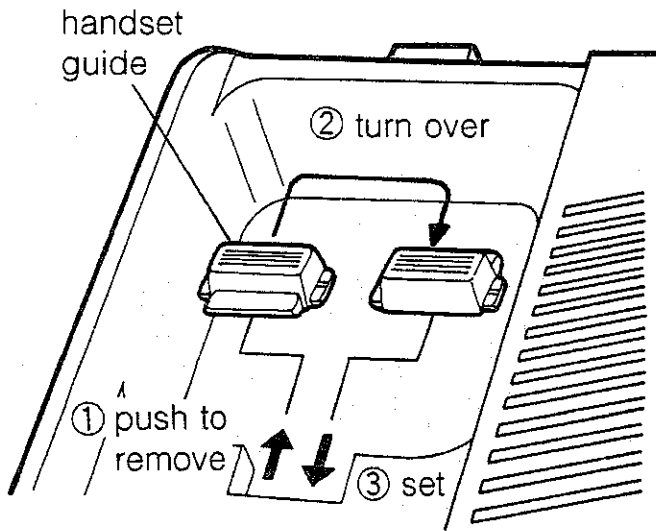

2. Insert the hook of the wall mounting adaptor into the hole of the unit then push it in the direction of arrow (A) as shown.

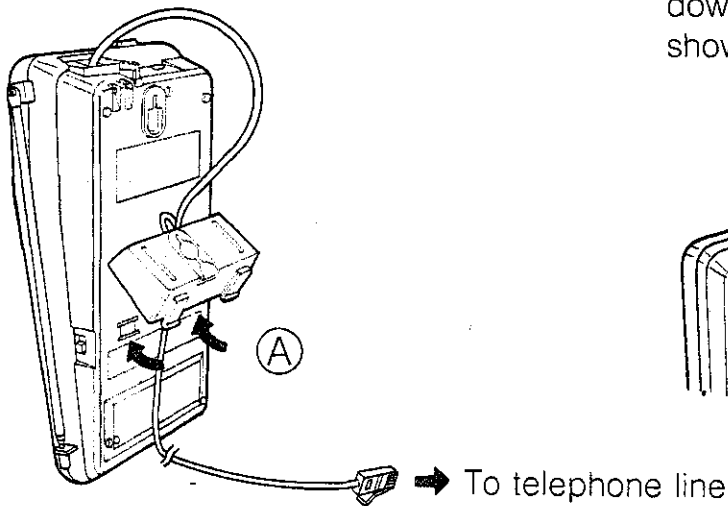

3. Using the washers fix the screws to the wall in the positions indicated.

4. Mount the unit on the wall so that the screw heads insert into the slots on the bottom, and then slide the unit down to hook it securely, as shown.

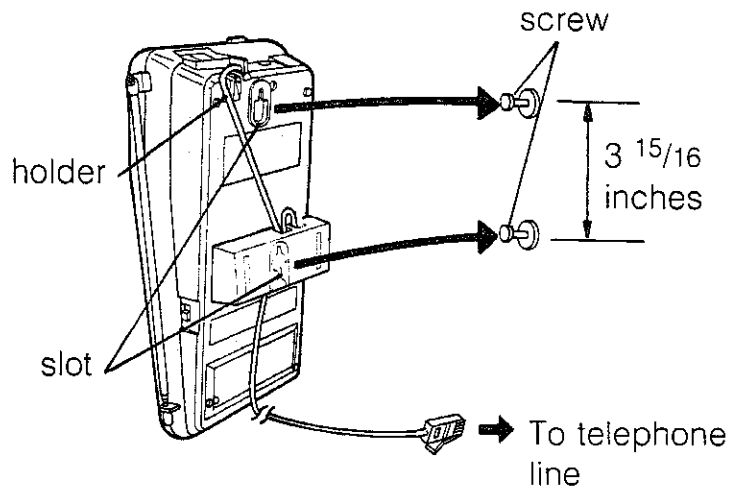

- To temporarily place the handset down during a conversation, hook as shown.

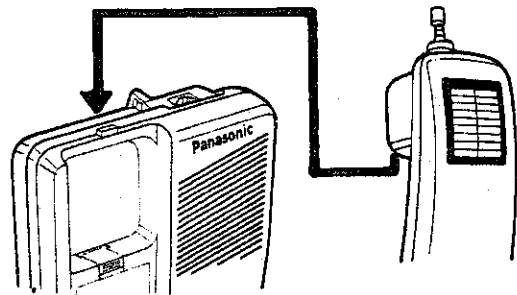

Wall Template

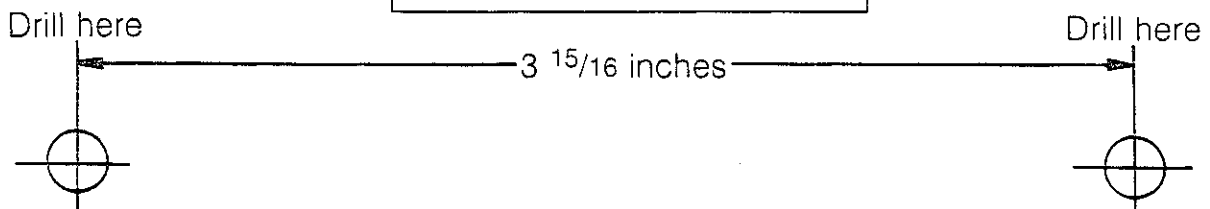

Shooting Guide

not work.

in need of charging.
Adaptor is not plugged into an outlet.
The line connection is made.
The line connection is made improperly.

is not heard.

above-mentioned possible causes.
You are too far from the base unit. Move closer to base unit.
The function selector to the "STANDBY" position then set it to the "K" position.

the portable unit does not ring.

Make sure the function selector is set to the "STANDBY" position.

Sound flutters or fades.

You are too far from the base unit. Move closer to base unit.
The telescopic antennas are not fully extended.

I charged the battery for 10 hours, but the BATT. LOW indicator flashes after a few telephone call.

It is time to change the battery.
Please replace.

While operating the unit the AC adaptor feels warm.

This is normal.

Others

- If there is any trouble, disconnect the unit from the telephone line and connect a known working telephone. If the known working telephone operates properly return your unit to your supplier for repair, if the known working telephone does not operate properly, consult with a telephone company.

WARNING:
TO PREVENT FIRE OR SHOCK
HAZARD, DO NOT EXPOSE THIS
PRODUCT TO RAIN OR ANY TYPE OF
MOISTURE.

When a failure occurs which results in the internal parts becoming accessible, disconnect AC adaptor immediately and return this unit to service center.

